



www.dignet.net.au

# LEDsmart™ Long Interval Timer

¼ hour to 7 ½ hour



Wall plate not included

Range METH / DGPB

## Overview

Designed in Australia, this electronic timer is designed to automatically switch lighting off after the timeout period programmed by the installer.

As part of the LEDsmart™ range, this timer enables dimmers, switches and timers to be combined onto the same wall plate, providing the user with a consistent interface.

## Features

**Timer is programmable** between ¼ hour and 7 ½ hour, in ¼ hour steps

**Timer override feature** to stop the lights turning off automatically

**Advanced 'warning' feature** to dim lighting to 50% level for 5 minutes after time out

**Mode to convert** from Long Interval timer to Short Interval timer.

**Programmable timer setting**, maximum level and off state indicator

**Simple 3-step** timer interval setting

**White LED**, illuminated bezel

**Flush and rocker style** button options

**Quiet, soft press button** – no harsh click

**Fall back LED Indicator**

**Settable** Low brightness indicator







**1W minimum** load

**Terminal block** included for AS3000 compliance

**Easy-fit** terminal block



## Specifications

Compatible Load Types			
Load Symbol	Load Type	Maximum Load	Notes
	LED Lamps	400W	The LED driver must be dimmable. Maximum permitted number of drivers is 400W divided by driver nameplate power rating. Due to variety of LED lamp designs, maximum number of LED lamps is further dependent on power-factor result when connected to timer.
	Electronic Transformers	400W	
	Standard Iron-Core Transformers	250W	Due to variety of transformer designs, maximum LV lighting load is also dependent on transformer efficiency.
	Toroidal Iron-Core Transformers	300W	
	Incandescent	350W	
	CFLs	400W	Due to variety of CFL designs, maximum number is make/model dependant.

### Multi-gang de-rating

In applications where multiple devices are installed in a multi-gang plate, a de-rating factor is applied to the maximum load as follows

Number of devices per plate	De-rating factor
1	No de-rating
2	0.85
3	0.70
4	0.55
5	0.40
6	0.25

### De-rating example

Two timers installed in a wall plate. The maximum LED load which can be connected to each timer = 400W x 0.85 = 340W per timer

### Incompatible Load types

Ceiling Sweep Fans and Exhaust fans

Nominal Line Voltage Amplitude Range	
Nominal Line Voltage Amplitude Range	220-240Vac
Line Voltage Frequency	50Hz Nominal (47-53Hz)
Default time out	½ hour
Rated Load	Refer Compatible Loads
Minimum Load	1W



## Dimensions

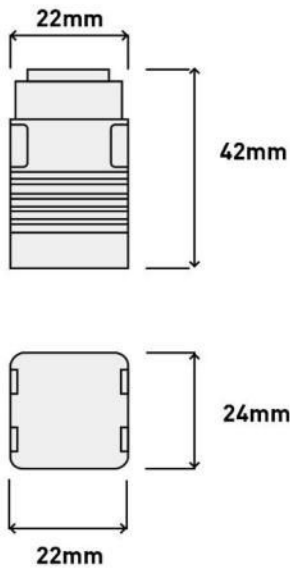

## Typical Electrical Connections

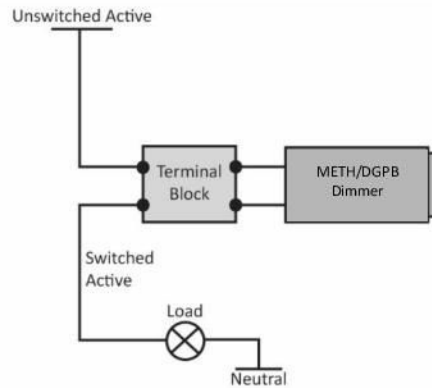

## Approvals & Compliance

IP20  

For further information contact:

**CTA** CONTROL TECH ASIA PTE. LTD.  
Lighting & Control for Architectural & Theatrical Spaces  
45 Genting Lane #03-02, Genting Complex, Singapore 349557  
Tel: +65-67420181 Fax: +65-67491681  
Email: [info@controltechasia.com](mailto:info@controltechasia.com)  
Website: [www.controltechasia.com](http://www.controltechasia.com)  
Company No.: 200802342R

## DIGINET IS A BRAND OF GERARD LIGHTING GROUP

The product includes a **TWO-YEAR WARRANTY** against manufacturing defects. Fully warranty terms can be found here [www.diginet.net.au](http://www.diginet.net.au)

**COPYRIGHT.** ©This document is copyright to Gerard Lighting Pty Ltd. Except as permitted under relevant law, no part of this user and installation guide may be reproduced by any process without written permission of and acknowledgement to Gerard Lighting. **DISCLAIMER.** Gerard Lighting Pty Ltd reserves the right to alter the specifications, designs or other features of any items and to discontinue any items at any time without notice and without liability. While every effort is made to ensure that all information in this user and installation guide is correct, no warranty of accuracy is given and Gerard Lighting shall not be liable for any error. **TRADEMARKS.** The identified trademarks and copyrights are the property of Gerard Lighting Pty Ltd unless otherwise noted.